

Design and fit-out guide for food businesses

Food Act 2006

September 2015

Design and fit-out guide for fixed food businesses

Published by the State of Queensland (Queensland Health), September 2015

The South East Queensland Food Safety and Public Health Working Group are acknowledged in their original development of this document.



This document is licensed under a Creative Commons Attribution 3.0 Australia licence. To view a copy of this licence, visit creativecommons.org/licenses/by/3.0/au

© State of Queensland (Queensland Health) **2015**

You are free to copy, communicate and adapt the work, as long as you attribute the State of Queensland (Queensland Health).

For more information contact:

Food Safety Standards and Regulation, Department of Health, GPO Box 48, Brisbane QLD 4001, email foodsafety@health.qld.gov.au, phone 3328 9310.

An electronic version of this document is available at www.health.qld.gov.au/foodsafety

Disclaimer:

The content presented in this publication is distributed by the Queensland Government as an information source only. The State of Queensland makes no statements, representations or warranties about the accuracy, completeness or reliability of any information contained in this publication. The State of Queensland disclaims all responsibility and all liability (including without limitation for liability in negligence) for all expenses, losses, damages and costs you might incur as a result of the information being inaccurate or incomplete in any way, and for any reason reliance was placed on such information.

Contents

Summary.....	3
1. How to use this guide.....	4
2. Planning and approvals	4
3. Design and layout	7
4. Floors.....	11
5. Walls and ceilings	13
6. Fixtures, fittings and equipment	16
7. Lighting	21
8. Ventilation	22
9. Hand washing facilities	24
10. Toilet facilities	26
11. Water supply	26
12. Sewage and wastewater disposal.....	27
13. Storage of rubbish and recycling materials	28
14. Storage facilities.....	29
15. Temperature measurement.....	30
16. Food transport.....	30
17. Mobile food vehicles	31
18. Home based food businesses.....	32
Example plans and sectional elevation drawings	34
Glossary	39
Acknowledgment	Error! Bookmark not defined.

Summary

Food businesses are required under *Food Act 2006* (the Act) to use premises and equipment that comply with Food Safety Standard 3.2.3 *Food Premises and Equipment* (Standards 3.2.3) of the *Australia New Zealand Food Standards Code* (the Code).

This guide is for businesses involved in the design, construction and fit-out of fixed and mobile food premises. It provides guidance to operators, architects, designers, builders, equipment manufacturers and other professionals associated with the design and construction of food premises.

The guide is based on Standard 3.2.3 and Australian Standard 4674-2004: *Design, construction and fit-out of food premises*. It aims to provide users seeking further information on how to comply with the requirements of the Standard with acceptable solutions on how they may meet the outcomes. The guide also provides some best practice options for those food businesses that choose to demonstrate a higher level of compliance.

Food safety begins at the earliest planning stages. The correct fit-out will assist in providing food premises that are easy to clean and maintain and will facilitate the production of safe food. There are cost advantages to the business in installing features to assist food safety practices at the time of construction.

This guide can be applied to premises used or intended to be used for the sale of food for human consumption including existing premises, new premises, domestic premises used for commercial purposes and mobile food vehicles. It does not, however, provide criteria for the design, construction and fit-out of temporary food premises such as market stalls.

1. How to use this guide

This guide provides solutions for designing or constructing food premises and is based on three concepts:

1. Food safety outcomes

Food regulation in Australia is outcome based. The Code articulates the desired results (outcomes) to be achieved by a food business rather than detailing prescriptive requirements which do not meet the needs of all businesses.

Outcomes based legislation allows food businesses to demonstrate how they meet the requirement and therefore operate their food business appropriate to their needs.

The food safety outcomes intended by Standard 3.2.3, can be found in the subheadings at the beginning of some sections of this guide.

2. Minimum requirements

Minimum requirements are measures that are recognised as acceptable solutions to demonstrate the minimum standard required to achieve compliance with Standard 3.2.3.

A number of acceptable solutions may be identified and listed for each outcome. Premises may need to use some or all solutions depending on the nature of the operation of the food business. Alternatively, you may be able to achieve compliance using a solution or method not listed in this guide. It is the applicant's responsibility to demonstrate that an alternative method complies with the requirements of the Code. Before implementing alternative methods of compliance, you are advised to seek advice from your relevant local government.

3. Best practice

Best practice is where the solution is considered to be above the minimum requirements. Best practice solutions are optional. Not all best practice options are listed in this guide. For more information on the best practice options available, contact the local government where your food business is located or relevant industry association.

NOTE

To obtain a copy of the Code or Food Safety Standards, go to www.foodstandards.gov.au

2. Planning and approvals

When designing, building or fitting out new food premises or making changes to an existing one, the first step is to develop plans or to obtain existing plans. The plans allow local government to assess the proposed food premises before construction or fit-out commences.

Before building or renovation starts, copies of all plans must be lodged with the local government where the food business is located with any required application forms and prescribed fees.

For further information relating to the types of plans required, applicable forms and prescribed fees, food businesses are recommended to speak with the relevant local government prior to having plans drawn.

General information required

Information generally required when you submit plans include:

- name, address and contact details of the architect, draftsman or shopfitter
- scale of drawing and date when plans were drafted
- name of food business operator
- address of the premises and real property description (i.e. lot and registered plan number)
- proposed name of premises and intended nature of the food operation
- a document providing a brief overview of the types of activities and food processing to be carried out on the premises as well as the types of food involved in the activities and processes.

Types of plans required

Copies of the following types of plans may need to be submitted to the local government where the food business is located. Your architect, draftsman, builder or shopfitter will be able to assist you in providing these.

- Site plan - to a suitable scale (e.g. 1:100) (not needed for mobile food vehicles) - including car parking, refuse storage area, adjacent land uses and toilet facilities.
- Floor plan - to a suitable scale (e.g. 1:50).
- Sectional elevation drawings - to a suitable scale (e.g. 1:50) showing all fittings and equipment.
- Hydraulic plans (plumbing details) - to a suitable scale (e.g. 1:50).
- Mechanical exhaust ventilation drawings (i.e. plans, elevation and schematic diagrams, where applicable) - to a suitable scale (e.g. 1:50).

Details required on plans

The following details for your premises should be included on the plans, drawings or as attached specifications to allow appropriate assessment:

- finishes to floors, walls and ceilings
- layout of all equipment, benches, fittings and fixtures, and mechanical ventilation
- door and window openings
- where seating is provided for diners, the number of square metres of floor space available for dining and the number of persons to be catered for in this area

- customer and staff toilet details (if detached, provide the distance to the facilities and the number available for use)
- mechanical exhaust ventilation (refer to Section 8)
- process flow, from product received through to end-product delivered

If you need further information on details required on plans, please contact the relevant local government where the food business will be located.

Other relevant approvals

When building your new premises or making changes to an existing food premises, it is essential that certain approvals are obtained in a certain order. By obtaining all the required approvals before starting construction, you reduce the possibility of expensive mistakes and avoid potential breaches of the relevant legislation.

The design approval checklist below assists in providing the relevant local government with applicable and correct information so your application can be processed without delay.

Please note, the checklist below is a guide only and further advice should be sought from the relevant local government.

Design approval checklist

The following approvals may be required to be obtained before starting construction of your food premises:

- Development assessment
 - check that under the Planning Scheme, you can operate the type of food business on the site you are considering
- Building
 - building approval may be needed from a local government or private certifier
- Plumbing
 - plumbing approval may be needed from the relevant local government's plumbing department and/or the relevant water authority
- Trade waste
 - obtain approvals for grease traps from the relevant water and sewerage supply entity if required
- Advertising signs
 - obtain approvals from the relevant local government
- Footpath dining permit
 - obtain approval from the relevant local government
- Goods on footpath permit
 - obtain approval from the relevant local government

3. Design and layout

General requirements

Required outcome

Food premises are required to be designed and constructed to:

- be appropriate for the types of food produced, activities conducted and capacity of the food business
- provide adequate space for all activities conducted and for all equipment to be used or stored
- allow easy cleaning and sanitising of all structures, fittings and equipment
- prevent entry of pests, dust, fumes, smoke and other contaminants
- exclude favourable sites for pests to harbour (live and breed)

Minimum requirements

Appropriate for use

Food premises design and layout should be planned taking into consideration several important elements which will ensure an effective and acceptable operation. Food premises design principles should accommodate the safe flow of food and waste to minimise the risks of food and equipment contamination. To achieve this, the separation of particular processes in the food premises should be considered including:

- raw and cooked foods
- hand washing facilities
- wash areas
- storage facilities
- waste disposal areas
- toilet facilities

NOTE

A properly designed and operated food business will minimise the risk of food becoming contaminated.

Flow of food through a food premises

The correct design and layout can help streamline work practices, reduce cleaning and maintenance and prevent cross contamination.

To prevent food contamination, premises should be designed so that the flow of food is in one direction from receipt to storage, preparation, packaging, serving and finally to disposal.

Figure 1 below depicts an appropriate flow of activities in a food business.

Figure 1: Example of correct flow of food and staff through a food premises

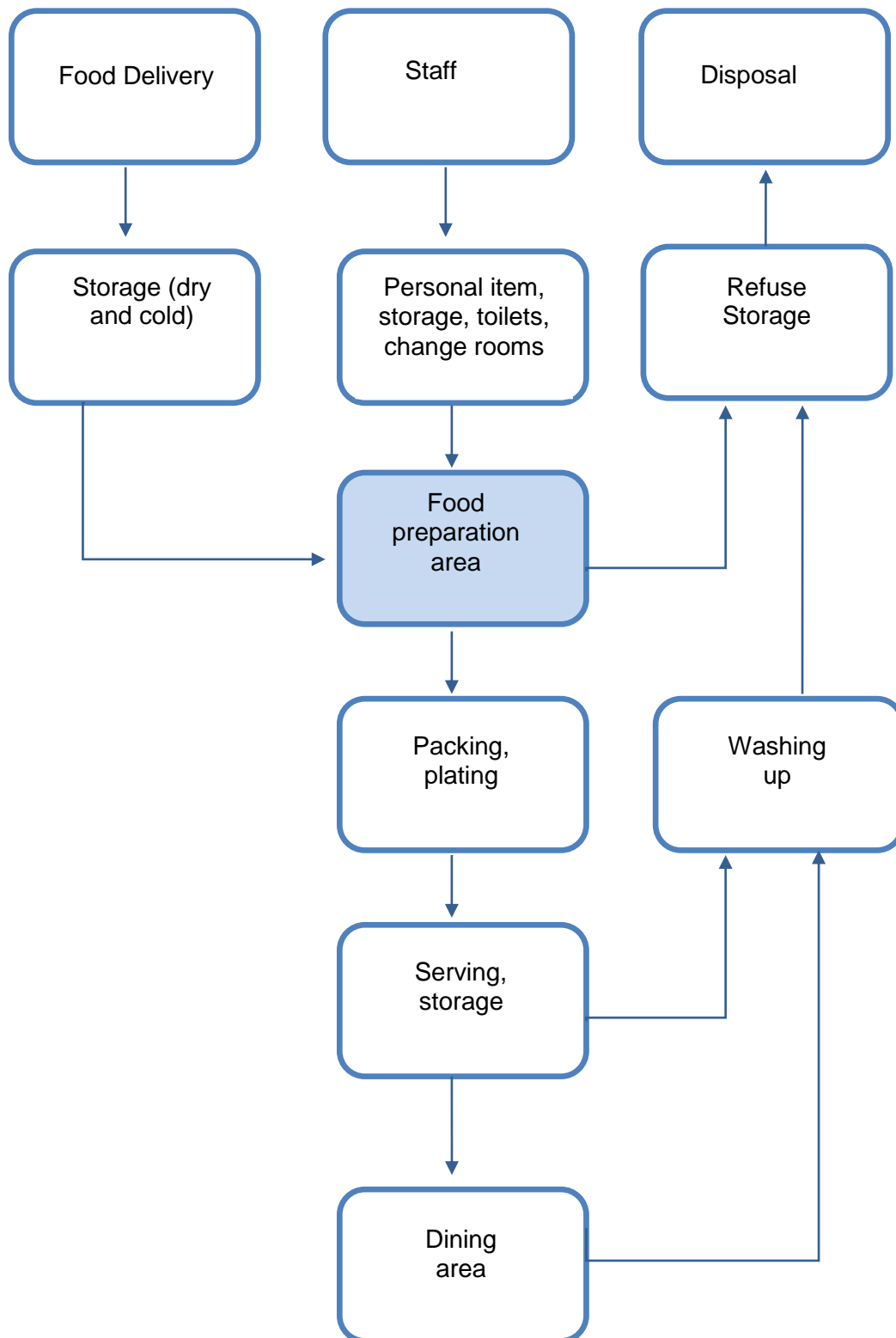

Adequate space

Proper planning of food premises will effectively designate adequate space and areas for food activities and storage of equipment.

Storage areas must be constructed of materials which are durable and easily cleaned in line with requirements for floors, walls and ceilings.

Adequate space is to be provided for:

- food delivery access
- dry goods storage - sufficient shelving space, pantry area and food grade containers for anticipated stock levels
- hot and cold food storage – adequate refrigeration, freezer and bainmarie (hotbox) food storage including in food preparation areas, display areas and expected deliveries
- cleaning chemicals and equipment storage - separate lockers, cupboards, cabinets or designated storage areas should be provided
- waste management - sufficient and separate waste containers for all anticipated waste including cardboard, glass, general waste, and waste oil storage should be provided. Waste bins must be impervious and designed to be easily cleaned to prevent the attraction of pests. Appropriate waste bin washing/cleaning area is to be considered
- personal belongings storage – separate lockers, cupboards, cabinets or designated storage areas
- food contact utensils storage – adequate storage containers that can be easily cleaned as well as preventing contamination
- equipment storage – sufficient floor, cupboard or shelving space for all cooking and food preparation equipment to be stored
- food packaging material storage - adequate storage located off the floor and protected from contamination
- office and business equipment (used to run the business) – must be separate from the food storage and preparation areas to prevent contamination

NOTE

Contamination of food, equipment and non-food materials can occur when improper storage facilities are used.

Cleaning, sanitising and maintenance

The design of all food premises must provide for suitable access for effective and efficient cleaning of all equipment, fittings, surfaces and areas.

The standard of cleanliness expected in a food business must ensure that there is no accumulation of garbage, recycled matter, food waste, dirt, grease or other visible matter.

It is important to understand that cleaning and sanitising are different procedures.

Clean means 'clean to the touch', that is, free from any dirt, dust or food particles that you can see and does not necessarily smell. Cleaning is the removal of these particles and/or smells.

Sanitise means to apply heat and/or chemicals (or other processes) to a surface so the number of microorganisms on the surface is reduced to a level that is safe for food contact and does not permit the transmission of infectious disease.

Cleaning and sanitising should usually be done as separate processes. A surface needs to be thoroughly cleaned before it is sanitised, as sanitisers are unlikely to be effective in the presence of food residues and detergents.

Food preparation areas

Adequate space must be provided for all food related activities and consideration to the capacity of the food business must be considered when designing a new premises or looking to move into an existing premises.

Dining areas

Dining areas are not required to meet the same requirements for floors, walls and ceilings as food preparation areas, however, adequate space must be provided for patrons and staff to access dining and serving areas.

Preventing entry of pests

All practical measures must be implemented to prevent entry of pests into food premises.

Internal structures are to be finished and designed to prevent favourable sites for pest harbourage. Acceptable methods of meeting this requirement include:

- installation of self-closing recessed doors or self-closing mesh screen doors with fitted weather strips
- mechanical air curtains and/or plastic curtains to minimise pest entry
- external windows should be either permanently fixed or fitted with tight fitting mesh screen that can be easily removed and replaced for cleaning
- all holes, service entries, gaps, crevices, cracks and voids are to be effectively sealed and smooth to allow easy cleaning
- insect control devices may be used but must not be located above or immediately adjacent to food preparation, open food storage or cooking areas to prevent food contamination. The insect control device is to be designed to capture and contain all insects within the device. It is to be installed according to manufacturer's specifications and cleaned on a regular basis.
- the use of chemical sprays (either mechanical or manual) are not permitted in food preparation working areas, over or near exposed food, unwrapped packaging or servery areas.
- installation of pest-proof roller doors may include:
 - installation of weather strips at the bottom of the roller shutters
 - sides of the roller shutters fitted tightly into the housing
 - installation of a pest-proof material at the top of the roller shutter to fill the gap usually left when the shutter is closed overnight

4. Floors

Required outcome

Floors must be designed and constructed so that they:

- are appropriate for the activities conducted on the premises
- can be easily and effectively cleaned
- do not absorb grease, food particles or water
- are laid so there is no ponding of water and
- are unable to harbour pests

Minimum requirements

Floor finishes for food preparation areas

Floors are to be finished with an appropriate material and laid to a smooth surface, free from cracks and crevices to facilitate effective cleaning. Table 1 shows the suitability of floor finishes in various areas within a food business.

It is recommended that floors are finished with one or a combination of the following materials in order to meet the minimum requirements of the Code:

- sealed quarry or ceramic tiles
- stainless steel, non-slip
- laminated thermosetting plastic sheeting
- epoxy resin
- steel trowel case-hardened concrete or similar impervious material
- floor tiles grouted with epoxy grout and finished flush with the surface of the tiles
- floors, draining to floor waste, sufficiently graded (at least 1:100)

Table 1 Suitability of floor finishes in food preparation areas

Finish	Water areas	Food preparation	Vegetable preparation	Servery	Store room	Chillers/ freezers	Bin store	Eating areas	Comments
Stainless Steel non-slip	✓	✓	✓	✓	✓	✓	✓	✓	Welded joints
Ceramic tiles	✓	✓	✓	✓	✓	✓	✓	✓	Epoxy grout
Quarry tiles	✓	✓	✓	✓	✓	✓	✓	✓	Sealed
Steel trowel case hardened concrete					✓	✓	✓	✓	Smooth sealed; finish no joints
Carpet/ carpet tiles								✓	
Wooden flooring								✓	Sealed
Poly vinyl sheet	✓	✓	✓	✓	✓	✓	✓	✓	Heat welded joints
Vinyl tiles			✓	✓	✓	✓	✓	✓	
Plastic matting				✓				✓	
Cork tiles								✓	Sealed
Epoxy resin	✓	✓	✓	✓	✓	✓	✓	✓	

NOTE

Where it is not practical to use one of the other floor finishes, the use of steel trowelled case hardened concrete that is smooth and impervious to moisture may be used in wet washed, food preparation and servery areas.

Food storage areas

Floors in storage areas for packaged food must be appropriate to the food business and type of food stored in this area. It is recommended as a minimum floors in storage areas have an impervious finish to allow for easy and effective cleaning.

Plinths

Plinths can be used to hold heavy equipment that is unable or difficult to move for cleaning. A plinth is the base or platform upon which a column, pedestal, statue, monument or structure rests.

Plinths are to be constructed to meet the same specifications as floors. They should be solid, without voids and sealed to allow effective and efficient cleaning.

The base of the equipment should be sealed to the plinth and overhang to prevent liquid, food or floor washing to access underneath the equipment.

Alternatives to the use of plinths include metal legs, castors or brackets.

Best practice

Coving

To facilitate effective and easy cleaning, it is recommended that coving be installed in areas where floors are intended to be or likely to be cleaned by flushing with water, at the intersections of walls to floors and floors to plinths in food preparation areas.

Coving is the process of turning up a sheet at the perimeter to provide a continuous surface between the floor and wall, or floor and other vertical surfaces.

Figure 2: Example of a plinth with coving



5. Walls and ceilings

Required outcome

Walls and ceilings must be constructed to:

- be appropriate for activities conducted on the food premises
- protect food from contamination
- prevent the entry of dirt and dust
- prevent absorption of grease, food particles and water
- ensure easy and effective cleaning
- prevent entry and harbourage of pests

Minimum requirements

Wall construction

- Walls are to be solid and of framed or preformed panel construction where voids can be filled with a suitable material.
- Joints between preformed panels shall be filled and finished flush with the surface of the sheeting material.

- Cover strips are not recommended in food preparation areas as they allow dirt and grease to accumulate.

HINT

Solid construction is defined as having structural integrity to support ceiling, heavy equipment and withstand the physical wear and impacts from its environment. Finishes should be smooth and unable to absorb grease, food particles, moisture and dirt allowing for easy and effective cleaning. Must prevent the entry of pests, vermin and dust (or other potential contaminants).

Wall finishes for food preparation areas

Walls are to be finished with a washable and easy-to-clean surface such as:

- glazed tiles (not suitable for wash down areas)
- stainless steel or aluminium sheeting
- acrylic or laminated plastic sheeting
- polyvinyl sheeting with welded seams
- pre-formed panels, villa board or compressed sheeting
- trowelled cement (polished surface) may be appropriate in some circumstances

Any finish continued above ceramic tiles should be finished flush with the tiles or sealed appropriately to prevent the accumulation of dirt and grease.

Architraves, skirting boards, picture rails or similar protrusions on the walls in food preparation areas are not recommended.

Walls at the rear of cooking appliances are to be surfaced with an impervious material, such as stainless steel, which extends from the canopy to the floor. Where a cooking appliance is sealed to the wall, the material should be lapped over the top edge of the appliance to provide a grease and vermin proof seal.

Splashback walls at the rear of benches, sinks and hand basins must be surfaced with an impervious waterproof material. It is recommended that splashbacks are a minimum height of 300mm.

Table 2 below shows the suitability of wall finishes in various areas within a food business.

Table 2 Suitability of wall finishes

Finish	Wet washed areas	Food preparation	Vegetable preparation	Servery	Store room	Chillers/ freezers	Bin store	Eating areas	Comment
Stainless steel	✓	✓	✓	✓	✓	✓	✓	✓	Welded joints & waterproof screw covers
Ceramic tiles	✓	✓	✓	✓	✓	✓	✓	✓	Epoxy grout
Vinyl sheets	✓	✓	✓	✓	✓	✓	✓	✓	Heat welded joints
Painted plaster					✓		✓	✓	Smooth finish
Feature brick								✓	
Aluminium sheet	✓	✓	✓	✓	✓	✓	✓	✓	Welded or sealed joints
Steel sheet							✓		Welded or sealed joints
Trowelled cement		✓	✓	✓	✓	✓	✓	✓	Polished surface
Wood panelling								✓	Wood sealed
Painted brickwork					✓		✓	✓	Flush joints and solid surfaces
Concrete					✓		✓	✓	Sealed smooth surface
Pre-formed panels	✓	✓	✓	✓	✓	✓	✓	✓	H bar joints mastic sealed.

Ceilings

The ceiling height in a food premises is not recommend to be less than 2.4m. Ceilings must be free of open joints, cracks and crevices.

The intersection of walls and ceilings are to be tight jointed, sealed and dust-proof.

The ceiling must be finished with a material that is washable and impervious.

Recommended materials for ceilings include:

- fibrous plaster
- plasterboard
- fibrous cement
- cement render with steel trowel

Drop in panels should not to be used in food preparation or display areas as they cannot be sealed properly.

Table 3 below shows the suitability of ceiling finishes in various areas within a food business.

Table 3 Suitability of ceiling finishes in food premises

Finish	Wet areas	Vegetable Preparation	Servery	Store room	Fridges/Freezers	Bin store	Eating areas	Comment
Painted plaster	✓	✓	✓	✓		✓	✓	Smooth finish
Steel Sheet	✓	✓	✓	✓		✓	✓	
Trowelled cement	✓	✓	✓	✓		✓	✓	Polished surface
Wood panelling							✓	Sealed surfaces
Concrete	✓	✓	✓	✓		✓	✓	Sealed smooth surface
Pre-formed panels	✓	✓	✓	✓		✓	✓	
Acoustic panels							✓	Suspended T-bars
Decorative panels							✓	

Pipes, conduits and wiring

Pipes, conduits and wiring should be concealed in floors, plinths, walls and ceilings to prevent the accumulation of dust and ease of cleaning.

For pipes, conduits and wiring fixed on brackets external to the wall, it is recommended that there is a suitable clearance between the pipe and adjacent surfaces to allow for ease of cleaning (a minimum of 25mm is recommended).

6. Fixtures, fittings and equipment

Required outcome

Fixtures, fittings and equipment must be:

- adequate for the production of safe and suitable food
- fit for their intended use

Fixtures, fittings and equipment, and food contact surfaces must be designed, constructed, located and installed so that:

- there is no likelihood they will contaminate food
- they can be easily and effectively cleaned and sanitised (where required) including eating and drinking utensils
- surrounding surfaces can be easily and effectively cleaned
- they do not provide harbourage for pests

Equipment for cleaning and sanitising

Minimum requirements

Facilities

Table 4 shows the cleaning and sanitising facilities recommended for undertaking food preparation, cleaning and sanitising activities.

Table 4 Cleaning and sanitising facilities required for various food premises

Food premises activities	Minimum facilities for cleaning equipment and preparing food
No food preparation/minor handling of pre-packaged food	Single bowl sink (capable of immersing the largest piece of equipment)
Handling unpackaged food	<ul style="list-style-type: none"> ▪ Double bowl sink (capable of immersing the largest piece of equipment), or ▪ Dishwasher/glass washer and single bowl sink (where all food contact equipment will fit in the dishwasher), or ▪ Double bowl sink and a dishwasher/glass washer (where some equipment has to be washed/sanitised in the sink)
Where food is prepared by immersion or rinsing in water	Designated food preparation sink in addition to necessary cleaning sinks
Where floors and equipment are to be hosed	Designated hose connection
Food premises activities	Appropriate facilities for cleaning equipment and preparing food as discussed above

Hot water supply

All equipment for cleaning and sanitising is to be connected to a continuous supply of hot and cold potable water and to an approved drainage system.

Sinks must be supplied with water at a temperature of not less than 54 degrees Celsius (°C) for washing and 77°C for sanitising (if sanitising takes place in the sink).

The best temperature for washing utensils in the food service industry is between 54°C and 60°C. Temperatures higher than this tend to bake food residue on.

Double and triple compartment sinks

Sinks should have a minimum bowl size to enable cleaning of large pots and equipment and have a splashback as part of the unit or appropriate surface to withstand water.

Loading, and draining or drying space appropriate to the food businesses activities and production capacity is to be provided.

Dishwashers and glass washers

Dishwashers and glass washers should meet the following requirements:

- be capable of completely washing and rinsing in one operation
- be designed so that all utensils, after rinsing, are dry by the end of the operating cycle
- be fitted with control devices to ensure the machine will not operate until the rinsing water is at the required temperature
- brushes are not included as part of the mechanism
- utensils to be rinsed for at least 10 seconds with:
 - water at a minimum of 38°C containing a minimum of 50 milligrams per kilogram (mg/kg) of sodium hypochlorite, or
 - water at a minimum temperature of 80°C
- be fitted with a thermometer clearly visible to the operator indicating temperature for the washing and rinsing operation or be fitted with an automatic pilot light visible to the operator which indicates that the water in the heating device has reached the correct temperature
- be equipped with a water heating device or be supplied with water from an individual hot water source
- be provided with an approved exhaust ventilation system (if required)
- be designed to use chemical sanitisers
- include a rinse cycle to ensure no chemical residue remains

Food preparation sinks

Where food preparation requires the washing of food and immersion in water, a designated food preparation sink should be provided. Designated food preparation sinks should be separate from all other sinks to prevent cross contamination and confusion over the sinks use.

Separation distance between sinks is to be determined having regard to the implicated risk of food or food contact surface contamination. This may be considered in conjunction with factors such as the operational flow of food production, the size and depth of the sinks concerned, the feasibility of any acceptable alternative engineering solutions e.g. the provisions of a physical barrier between the sinks.

Equipment for food preparation and storage

Minimum requirements

Temperature gauges

Hand held probe thermometers that are accurate to +/- 1°C are to be used to measure the internal temperature of the food.

Chilled and frozen storage

All cold storage and cold display equipment must be large enough for the business to adequately store cold food.

All cold storage and display equipment must keep potentially hazardous food at a temperature of 5°C or less.

Refrigerators, cold rooms and blast chillers must be capable of reducing the temperature of potentially hazardous food in accordance with Clause 7 of Food Safety Standard 3.2.2. That is, from 60°C to 21°C within the first two hours and from 21°C to 5°C within a further four hours.

Freezers are to keep food frozen hard.

Cold and freezer storage rooms

The walls of coldrooms and frozen storage rooms are to be lined with a smooth and impervious material with all joints sealed.

Floors are to be a smooth and impervious material, preferably coved at the floor to wall junction.

Floors are to be graded to the door opening and to a floor waste located outside the room, which is connected to the sewerage network or effluent disposal system.

Doors must be able to be opened from the inside and an alarm fitted in accordance with the requirements of the Building Code of Australia.

Shelving is to be made of suitable materials (eg. galvanised piping with sealed ends or stainless steel), must be easy to remove for cleaning. It is recommended that the lowest shelf is at least 100mm off the floor to allow for easy cleaning, however, if shelves are on castors and are easily moved this is not necessary.

Coldrooms and frozen storage rooms are preferably to be sealed to the walls to prevent harbourage of vermin. Alternatively, they should be located a suitable distance from the wall to enable access for cleaning.

Enclosed areas above cold and freezer rooms are to be pest proofed.

External cold and freezer rooms are not recommended unless an approved enclosed access is provided (bulk cold/freezer stores and packaged food are exempt from this requirement).

Motor units are recommended to be located external to the premises to increase performance of the motor, reduce noise in the food business and not encourage the harbourage of pests.

HINT

The position of externally mounted cold and freezer room motors should be carefully considered to prevent any noise nuisance to nearby residences and businesses. Units should be placed away from bedroom and office windows, multiple walls and corners.

Preparation, cooking, and hot and cold display

All equipment for preparation, cooking and display must be constructed to be easily and effectively cleaned with no cracks, crevices and joints where food and liquids can collect.

Hot and cold food storage and display units must be capable of maintaining food under temperature control (i.e. 5° C or below or 60° C or above).

Benches, tables and preparation counters

Benches and tables are to be constructed so that they are able to be easily and effectively cleaned and sanitised. Examples include laminated timber, plastic or stainless steel with pest-proof joints.

Benches fixed against a wall should be sealed to the wall with an appropriate material.

Sandwich counters, used to prepare food in front of customers are recommended to be fitted with a protective barrier between the customer and the food to prevent contamination.

Equipment placed on bench tops should be either:

- easy to move
- raised above the bench top to allow easy access for cleaning
- sealed to the bench top

Cooking equipment

Stoves and cooking appliances are to be either kept clear of walls to enable access for cleaning or sealed into walls and completely pest proofed.

It is recommended that deep frying equipment is thermostatically controlled to prevent a fire hazard from the overheating of cooking oils and consideration is given to ensuring the premises is equipped with a suitable fire extinguisher or fire suppression system located near the cooking equipment.

Miscellaneous

Post-mix/syrup and ice machines should be located inside the food premise.

Food conveyors should be constructed of smooth impervious surfaces, free from cracks, crevices and open joints, with access provided for easy cleaning.

Supports for equipment

Metal legs should be smooth and sealed to prevent the access of pests and be high enough to allow for easy cleaning.

Castors or wheels must be capable of supporting and moving the fully-loaded equipment.

Timber frames and supports should be sealed to allow for efficient and effective cleaning.

Shelving

Must be smooth and impervious, free from joints, cracks and crevices and able to be easily and effectively cleaned.

The lowest shelf should be of a height off the floor to allow easy cleaning underneath.

Windows and ledges

It is recommended that windows and ledges are located a minimum of 300mm above benches, sinks or hand basins to provide for appropriate splashback.

Cupboards and cabinets

Cupboards and cabinets are to be smooth, impervious and washable.

Best practice

Temperature gauges

Temperature gauges must be accurate to +/- 1°C and must be fitted to each hot and cold storage or display unit; must be clearly visible and fitted to show the internal operating temperature in the:

- coolest part of the appliance for hot display
- warmest part of the appliance for cold storage and display

NOTE

Fixed thermometers in units are to be used as a guide only. The use of a probe thermometer in the food will give a more accurate indication of food storage temperatures.

Areas above cold/freezer rooms

The area above cold/freezer rooms (if exposed) must be fully-enclosed with vermin-proof access hatches to allow pest control treatment to be undertaken.

7. Lighting

Required outcome

Food premises must have a lighting system that provides sufficient natural or artificial light to enable staff to conduct activities safely within the food premises.

Minimum requirements

Lighting system

A food premises must provide sufficient lighting to adequately illuminate all areas of the food premises to enable food handlers to:

- readily see whether food preparation areas and equipment are clean
- detect signs of pests
- clearly see the food and equipment they are handling

Light fittings

In areas where food is handled or stored, light fittings must be designed with the following specifications:

- should be shatterproof or fitted with approved light diffusers (covers or shields) to prevent contamination of food by glass from a broken light globe/tube
- be free from any feature that would collect dirt or dust, harbour insects or make the fitting difficult to clean
- be recessed into ceilings or equipment where possible
- heat lamps must be protected against breakage by a shield extending beyond the bulb

NOTE

Adequate lighting provides cleanliness by exposing any unclean areas. Light diffusers (covers or shield) prevent contamination of food from glass fragments in the event of breakage.

8. Ventilation

Required outcome

Food premises must have sufficient natural or mechanical ventilation to effectively remove fumes, smoke, steam and vapours from the food premises.

Minimum requirements

Natural ventilation

Natural ventilation is only suitable where there is little or no cooking that generates steam or greasy air.

The premises must have openings, such as doors, windows and/or vents open to a clean environment.

Mechanical ventilation

The Building Code of Australia requires a commercial kitchen to be provided with a mechanical ventilation system that complies with the applicable Australian Standard where:

- any single apparatus has:
 - a total maximum electrical power input exceeding 8 kilowatts (kW), or
 - a total gas power input exceeding 29 megajoules per hour (MJ/h), or
 - the total maximum power input to more than one apparatus exceeds:
 - 0.5kW electrical power for each 1m² of floor area of the room or enclosure, or
 - 1.8MJ gas for each 1m² of floor area of the room or enclosure
- dishwashers and other washing and sanitising equipment that vent steam into the area to the extent that there is, or is likely to be, condensation collecting on walls and ceilings
- equipment installed in the premises after the mechanical ventilation system has been designed and installed must not impair the efficiency of the system or the natural ventilation

In the case where no general exhaust is provided to remove fumes, smoke, steam and vapour from an enclosed kitchen, a local mechanical exhaust system may be required even if the power input of the apparatus does not exceed the thresholds of the applicable Australian Standard.

Filters

Canopies are to be fitted with grease filters which can be removed for easy cleaning. The filter must comply with the applicable Australian Standard.

NOTE

While Australian Standard 1668.2 - 1991 was superseded by Australian Standard 1668.2 – 2002, AS 1668.2- 1991 still applies as the BCA includes reference to Australian Standard 1668.2- 1991– The use of mechanical ventilation and air conditioning in building– Part 2: Mechanical ventilation for acceptable indoor- air quality (“the 1991 standard”). The Australian Building Code board has issued an advice dealing with the reasons for maintaining the reference to the 1991 standard in the BCA, rather than the 2002 standard

Food premises exhaust hood airflow

The airflow required for a food premises exhaust hood will depend on the:

- hood type
- cooking process
- length of the hood
- inside perimeter of the hood over all exposed sides
- height of the hood above cooking appliances

Compliance certificates from a Registered Professional Engineer may be required by the relevant local government for both the design and construction of the hood to verify compliance.

HINT

Always consider mechanical extraction systems when building new premises or renovating existing premises, as it is more expensive and inconvenient to install these systems once the business is operating.

Discharge point

Exhaust should not discharge over adjoining properties or where the discharge is less than 3m above any pedestrian thoroughfare including an accessible roof area.

Exhaust ventilation for wood-fired and solid fuel cooking equipment needs to be separate to other ventilation systems and must not be combined with systems serving grease appliances, or oil generating or oil-heat appliances.

Dining areas

Dining areas are to be ventilated by natural or mechanical methods in accordance with the Building Code of Australia and relevant Australian Standards.

For design specifications, refer to Australian Standard 1668.1-1998 and Australian Standard 1668.2-1991. All mechanical exhaust hood systems should be designed by a Registered Professional Engineer specialised in the field of mechanical ventilation (e.g. Australian Institute of Refrigeration, Air-conditioning and Heating Certified) and certified upon completion to ensure compliance with the Australian Standard and the Building Code of Australia requirements.

Additional considerations should be given to the nuisance effects of noise and odour emissions upon the surrounding environment.

It is advisable when constructing a new premises, to allow for possible future expansion of cooking equipment.

9. Hand washing facilities

Required outcome

The food premises must provide hand washing facilities located where they can be easily accessed by food handlers:

- within areas where food handlers work if their hands are likely to be a source of contamination and
- immediately adjacent to the toilets

Hand washing facilities must be:

- permanent fixtures
- provided with a supply of warm potable running water
- a size that allows easy and effective hand washing
- clearly designated for washing of hands, arms and face only
- be provided with a supply of soap or other item that may be used to thoroughly clean hands, single use towels or another means of effectively drying hands that are not likely to transfer pathogenic micro-organisms and a container for used towels if needed

Minimum requirements

Thorough washing and drying of hands is an essential activity in a food business to reduce the risk of food contamination and food-borne illness.

Hand washing facilities must be:

- located within an adequate distance from all food handling areas
- located in or immediately adjacent to toilets
- provided with warm potable running water delivered through a single outlet (i.e. hot and cold water provided through a single outlet)
- provided with an adequate supply of soap or other suitable cleanser
- provided with single-use paper towels and suitable dispenser or other approved hand drying facility in the immediate area of the hand basin
- of a suitable size to allow cleaning of hands, arms and face

- unobstructed by any other equipment and easily accessible
- not located under benches, i.e. an appropriate hand basin height is usually 900 mm off the floor

Splashguards may be required to prevent contamination of nearby equipment, benches or other areas from the hand washing facility. Rubbish containers located in the immediate area for the disposal of paper towels must be located and designed to prevent contamination of adjacent food contact surfaces, food, utensils, cleaning equipment and storage areas.

HINT

Signage at hand wash basins, “Have you washed your hands?” and/or “Hand washing only” is often a great reminder for staff.

Best practice

Hand washing facilities as best practice should:

- be located at staff entrances to the food premises
- have a self-closing or metered tap to provide a flow of water for at least 15 seconds without the need to reactivate the tap
- be provided with hands free devices (such as a knee operated lever, single lever taps or sensor taps).

Figure 3: Typical hand washing facilities

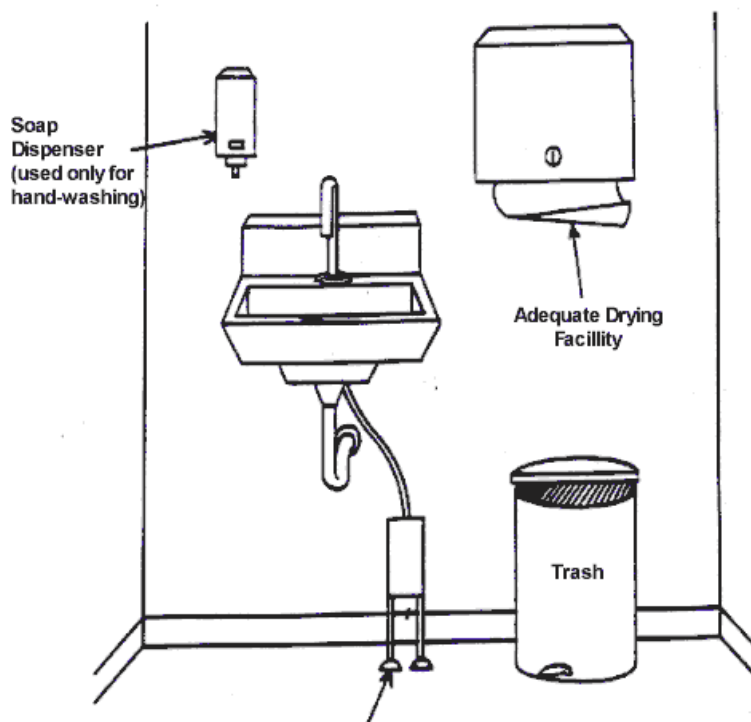

10. Toilet facilities

Required outcome

A food business must ensure that adequate toilets are available for the use of food handlers working for the food business.

Minimum requirements

A food premises must comply with the requirements of the Building Code of Australia for provision of toilet facilities, including:

- number of toilets
- staff and public toilet facilities to be equipped with appropriate hand washing facilities
- toilet facilities to be clean and in good repair
- toilets located within the food premises are to be separated from areas where food is handled, displayed or stored by an air lock equipped with self-closing doors, or fitted with self-closing doors and provided with mechanical ventilation that operates when in use and thirty (30) seconds after the cubicle is vacated

Best practice

Separate toilet facilities for both staff and customers should be provided.

11. Water supply

Required outcome

Food premises must have an adequate supply of potable water for all activities that use water that are conducted on the food premises. (Potable water is safe drinking water that is fit for human consumption.)

Minimum requirements

A food premises is to meet the following criteria:

- constant hot and cold water is to be available at all times, including during periods of high demand/usage
- running potable water under pressure is to be provided in sufficient quantity to carry out all food preparation, utensil washing, hand washing, cleaning and other water using operations
- warm potable water (i.e. hot and cold water provided through a single outlet) is to be provided at all hand washing facilities to ensure effective hand washing
- hot water unit(s) that are capable of delivering an adequate supply of hot water are to be installed
- hot water must be of a sufficient temperature to effectively clean and sanitise equipment

- hot water that is provided to dishwashers must be supplied as per the manufacturer's guidelines, e.g. sufficient pressure

NOTE

For further information on water quality refer to the Australian Drinking Water Guidelines at www.nhmrc.gov.au

Premises not connected to town water supply

Premises that are not connected to a town water supply must ensure potable water is used in the food premises. This may require the implementation and maintenance of a treatment and monitoring system. Such a system may include filters, UV, ozone, chlorine and regular testing.

12. Sewage and wastewater disposal

Required outcome

The food premises must have a sewage and wastewater disposal system that effectively disposes of sewage and wastewater which is constructed and located so that it does not contaminate food or the water supply.

Minimum requirements

Food premises are to provide appropriate facilities and plumbing infrastructure to ensure that sewage and all wastewater generated are disposed of appropriately.

The design (hydraulics plans) and installation of sanitary plumbing and drainage must comply with the relevant Australian Standard and be approved by your relevant local council.

It is recommended that the food premises be designed with the following criteria:

- installation and maintenance of a grease trap designed to filter grease and oil generated from the food business operations (where applicable). The installation and maintenance of a grease trap requires a Trade Waste Permit. For more information, contact your relevant local government or water authority.
- wastewater generated from mop buckets, cleaning mops and other cleaning activities must be disposed of in a cleaner's sink or other approved manner, but not disposed of via sinks used for food preparation or cleaning and sanitising of equipment.
- access openings to the sanitary drainage system and grease traps are not to be located in areas where there is a risk of food contamination. All access points to grease arrestors are to have a tight fitting lid that will not buckle, warp or rust to prevent the entry of pests and vermin.
- a food premises may utilise an approved drainage system for external waste storage to dispose of contaminated liquid waste.

- to allow effective floor cleaning procedures, cold rooms should have an external floor waste drain located adjacent to the door.
- equipment generating liquid waste must be connected to an approved tundish for correct discharge, e.g. cold room evaporative units/liquid holding hot boxes, or removed in some other approved manner.

13. Storage of rubbish and recycling materials

Required outcomes

Food premises must have facilities for the storage of rubbish and recycling materials that:

- are adequate to contain the volume and type of refuse on the food premises
- enclose the refuse to prevent access by vermin and animals
- are designed to be easily and effectively cleaned

Minimum requirements

Rubbish and recycling storage must:

- be adequate for the volume and type of waste produced by the business
- be able to be easily cleaned
- not provide a breeding ground or attract pests and vermin

External refuse and recycling storage areas should be:

- paved with an impervious material
- graded and drained to the sewer
- able to be easily cleaned
- capable of storing the rubbish generated from the business, e.g. wet waste, cardboard and general dry wastes, bulk waste oil, without creating the risk of providing a potential harbourage area for vermin

Consideration should also be given to the location of external waste storage areas and to their potential nuisance implications on neighbouring properties.

Rubbish and recycling containers are to be:

- constructed of an impervious material such as metal or plastic
- fitted with tight fitting lids (where necessary when located externally)
- maintained in good condition to prevent the access of pests and vermin

Garbage chutes, where installed, are to be constructed of an impervious, durable material.

Bins that cannot be lifted for cleaning are to have drainage bungs at the base.

Rubbish rooms (where installed)

Must be pest and vermin-proof and constructed of a solid material with a smooth surface to allow for effective and efficient cleaning.

The floor should be graded and drained to an approved floor waste and connected to sewer in an approved manner. The room should have a hose and tap connected to the water supply for ease of cleaning.

If mechanical ventilation is used, it must comply with the relevant Australian Standard.

Best practice

External refuse and recycling storage areas should be covered and provided with a hose and tap connected to a water supply.

HINT

Any external waste storage areas are to comply with the relevant waste laws.

14. Storage facilities

Required outcomes

Food premises must have adequate storage facilities for items that are likely to be a source of food contamination, including chemicals, clothing and personal belongings.

Storage facilities must be located where there is no likelihood of stored items contaminating food or food contact surfaces.

Minimum requirements

Dry goods and food packaging materials

Adequate storage is to be provided for dry goods and packaging materials in a sealed room with appropriate flooring.

Cleaning chemicals and equipment

Chemicals, cleaning equipment, pest control chemicals and equipment are to be:

- enclosed in cupboards located away from the preparation and storage of food where there is no likelihood of stored items contaminating food or food contact surfaces
- designated for that use only

Clothing and personal effects

Adequate facilities are to be provided for staff to store personal belongings that consist of either:

- a change room, or
- enclosed cupboards for the storage of clothing and personal belongings, located away from the food preparation and storage areas

Office materials

Storage of paper work and other materials associated with the administration of the business should be stored in an area designated for that use, such as enclosed cupboards or drawers or a separate room which is separate from food preparation and storage areas.

15. Temperature measurement

Required outcome

A food business where potentially hazardous food is handled must have a temperature monitoring device that:

- is readily accessible
- can accurately measure the temperature of potentially hazardous foods

Minimum requirements

All food premises where potentially hazardous foods are handled must have a temperature measuring device with an accuracy of +/- 1°C that is easily accessible at all times.

While the use of mercury and glass thermometers has not been prohibited, these thermometers if they are accurate to +/- 1°C must be used in a shatterproof protector to protect from breakage.

It is preferable for a food business to have a stainless steel digital probe thermometer that can be placed into food to accurately measure core temperatures, however, a suitable infra-red thermometer is also appropriate to measure the surface temperature of food depending on the food business operations.

All thermometers are to be in good state of repair and in working order. This means food businesses must ensure flat batteries are replaced, it is fixed or replaced if broken and maintained to an accuracy of +/- 1°C via calibration.

16. Food transport

Required outcome

Vehicles used to transport food must be designed and constructed to protect food if there is a likelihood of food being contaminated during transport.

Parts of the vehicle and food contact surfaces used during transport must be designed and constructed so that they can be effectively cleaned.

Minimum requirements

Food must always be transported in a way that minimises the risk of contamination.

Food transport vehicles that store potentially hazardous food must be capable of maintaining product at required temperatures at or below 5 °C or, at or above 60 °C.

The design of a food transport vehicle and containers must allow for easy cleaning procedures and protect transported food against contamination.

Food transport vehicles must be approved by the relevant local government, however do not have the same requirements as a mobile food premises.

17. Mobile food vehicles

Required outcome

When designing and fitting out a mobile food vehicle, it must meet the required outcomes from the Food Safety Standards the same as a fixed premises such as a restaurant, takeaway food outlet or café.

What is a mobile food premises?

Mobile premises, for a food business, means-

- a vehicle from which a person sells unpackaged food by retail, or
- a food vending machine.

A vehicle is defined as anything, whether operational or not, used to carry anything or any person by land, water or air. It should be noted that the definition for a mobile premise relates to a vehicle, not a motor vehicle.

Mobile premises are generally considered to be permanent set ups where the lay out does not change, yet the premises can be moved between locations. Mobile premises and may include caravans, ships, food carts or movable buildings such as demountable buildings or containers.

Mobile premises do not include food transport vehicles used to transport food for off-site catering or for the home delivery of food by order (e.g. pizza home delivery).

A food vending machine means a machine or device operated by money, token, debit card or credit card and used, or intended for use, for the sale of food. This component of the guide relates to mobile food vehicles only.

Minimum Requirements

Walls, floors and ceiling

Walls, floors and ceiling of the food preparation and storage areas of the vehicle must comply with sections 4 and 5 of this guide. They must be:

- appropriate to the operations of the business
- easily and effectively cleaned
- prevent absorption of grease, food particles and water
- prevent the entry and harbourage of pests

Door and service openings

Doors and serving hatches should be finished on the internal sides with the same standard of material as the walls.

The driving compartment of the vehicle should be separated from the food preparation and storage section.

All openings should be fitted with close-fitting doors and shutters that are vermin-proof and able to be closed during transport.

Water

Should the operations of the food business require washing facilities, a storage tank with a 90L capacity is recommended as a minimum size to be installed in the vehicle. This tank is to be filled with potable water and supply sinks and basins with appropriate pressure necessary for the individual operations.

A wastewater tank of adequate capacity (ie, 100L capacity in the case of a 90L water tank) is to be fitted to the vehicle where a water tank is installed. A back flow prevention device should be fitted to prevent any possible source of contamination.

Wastewater should only be disposed of in accordance with the relevant local government requirements.

Rubbish disposal

Separate designated rubbish containers should be factored into the design to ensure there is no contamination. Rubbish is to be disposed of in an appropriate manner.

Use of the premises

Mobile food vehicles are not to be used for sleeping or any other activity that has the potential to contaminate food prepared or stored in the vehicle.

Ventilation Requirement

When mechanical ventilation is required, the system must be constructed to comply with the relevant Australian Standard.

Special requirements

If the mobile food vehicle is to be used to sell food on public land (including roads), operators should contact the local governments where they will be operating to determine if other permits such as roadside vending permits are required.

18. Home based food businesses

Required outcome

Home based food businesses need to comply with all of the Food Safety Standards in this guide. However, as these types of premises often undertake limited amounts of food handling, alternative solutions can be applied to these businesses.

While there are not separate requirements for home based food businesses, it is expected that authorised persons will exercise professional judgement when assessing home based food businesses on a case by case basis relevant to the food being prepared, the individual layout of the home and individual circumstances.

Prior to commencing a home based food business, operators should contact the local government for the area in which they reside to seek further guidance and information.

Minimum requirements

Walls

Walls in the food preparation and storage area must be smooth, impervious and easily cleaned.

Floors

Must be smooth, impervious and easy to clean. Materials, such as polished cork and polished floorboards are acceptable when well maintained.

Benches and cupboards

Domestic style benches are acceptable provided they are in good condition and have impervious surfaces.

Hand wash basins

A basin for hand washing should be located in or close to the food preparation area. These basins must have a supply of warm potable water, soap and paper towels or other approved hand drying devices.

Dishwashing

Dishwashing shall be undertaken via a double bowl sink, or a dishwasher and a single bowl sink.

Ventilation

In domestic premises, the type and size of cooking appliances is usually not within the scope of the relevant Australian Standard. Domestic mechanical systems are usually sufficient to remove greasy fumes produced by cooking. Contact your relevant local government for advice on the right mechanical ventilation before installation. The system needed will depend on the type of equipment you will be operating and the amount of cooking being done.

Potable Water Supply

The premises must have an adequate supply of potable water for all activities that use water that are conducted as part of the food premises as well as other activities from the home.

Storage Facilities

A dedicated storage area specific for the storage of cooking utensils and food should be provided. This area is to be separate from domestic supplies.

Pets in the home

The Food Safety Standards prevent live animals in areas which food is handled other than seafood or other fish or shellfish. This requirement also extends to home based food businesses. It is therefore not considered appropriate that a home based food businesses will have domestic pets inside their home at any time.

Example plans and sectional elevation drawings

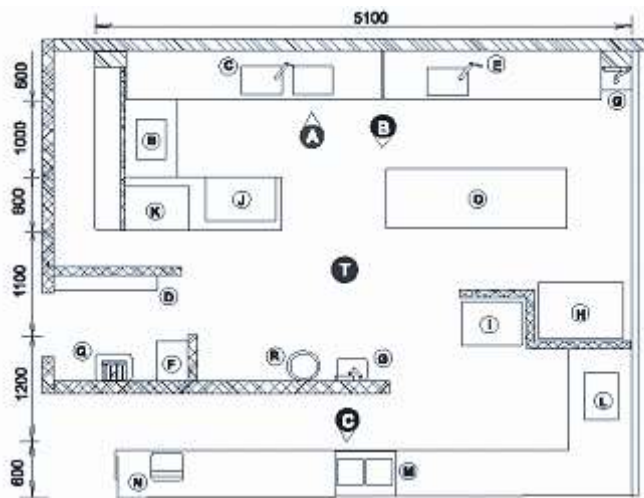

FLOOR PLAN

- A Mechanical exhaust
- B Fryer
- C Stainless steel
- D Staff personal effects storage
- E Stainless food preparation sink
- F Chemical storage unit
- G Stainless steel hand wash basin 400mm by 500mm
- H Upright scope commercial refrigeration unit
- I Scope upright drinks fridge
- J Dry goods pantry
- K Commercial pie warmer
- L Coffee
- M Refrigerated display cabinet
- N Cash register
- O Stainless steel food preparation bench
- P General waste bin
- Q Cleaners sink
- R Waste bin
- S Storage cupboard
- T Floor waste drain

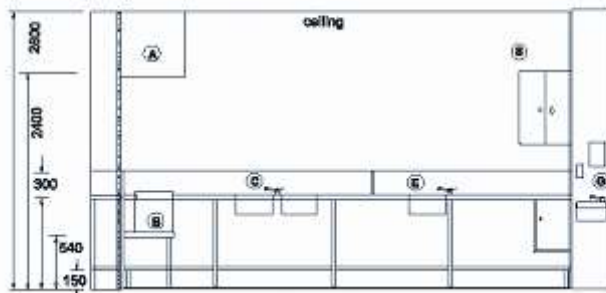

VIEW 'A'

ceiling

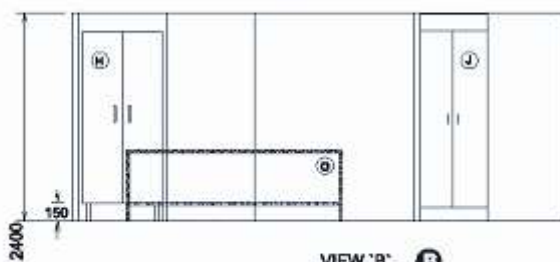

VIEW 'B'

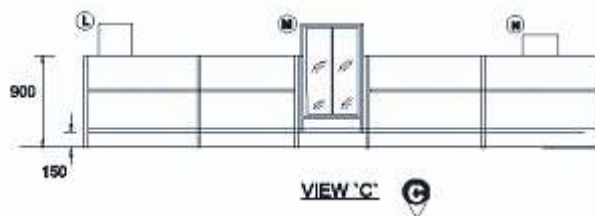

VIEW 'C'

- FLOOR Ceramic tiles and coving to all walls.
- WALLS Timber framing.
- WALL LINING 10mm plasterboard gloss enamel finish.
- BENCHES Stainless steel bench and frame.
- FRONT COUNTER Laminex bench top.
- CEILING Sealed plasterboard tiles gloss enamel finish.

- PLUMBING ss basin, knee operated mixer tepid & cold water ss sinks, lever mixer tap, hot and cold water.
- BACKFLOW PREVENTION Air gap to all tapware. Dual check valve to coffee machine.

2D example plans

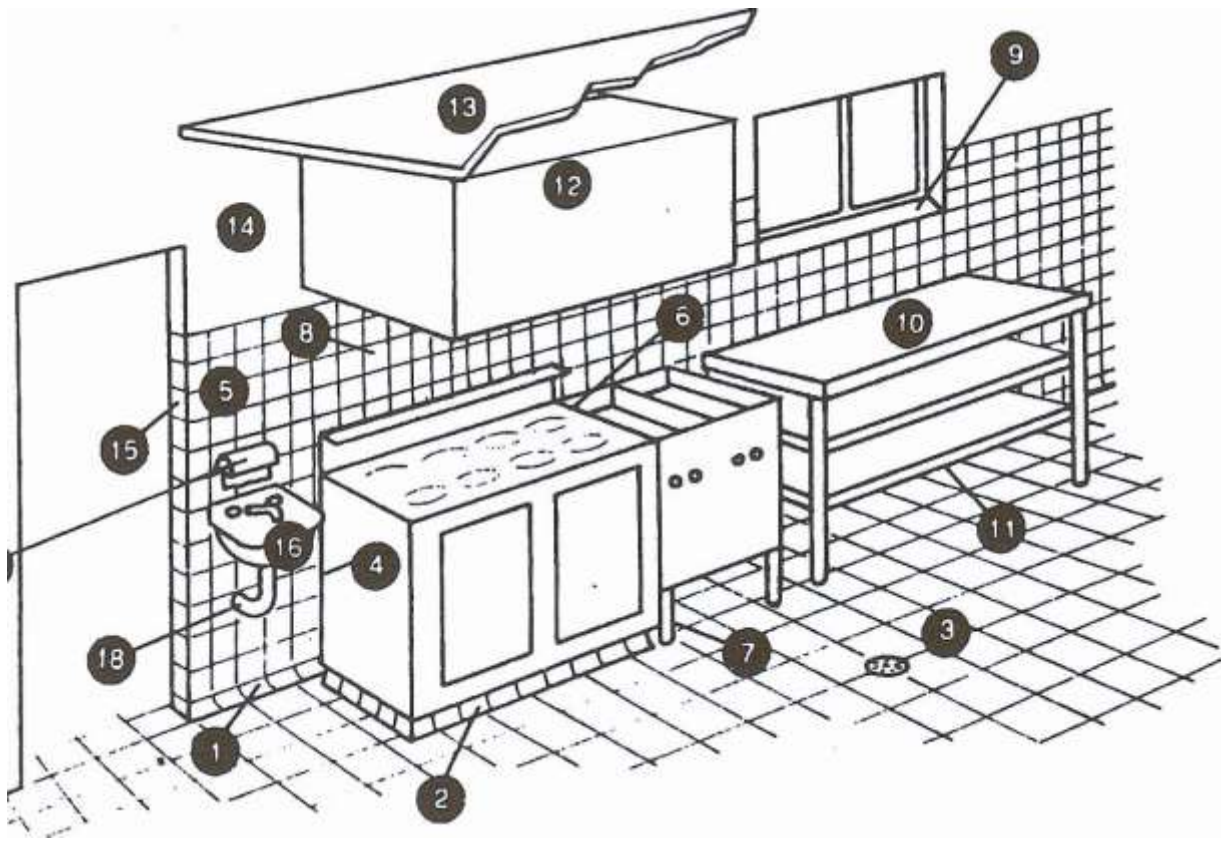

Requirements – typical food preparation area

1. Floor/wall coving as per section 6
2. Plinth
3. Impervious floor graded and drained
4. Fittings sealed to wall
5. Walls finished as per section 7
6. Sealing between fittings
7. Legs to allow effective and easy cleaning
8. No storage shelves below canopy
9. Splayed windowsill
10. Preparation bench
11. Bottom shelf height above the floor to allow effective and easy cleaning
12. Mechanical exhaust ventilation canopy
13. Rigid smooth faced ceiling
14. Smooth trowelled cement (polished surface)
15. No timber door frames
16. Hand basin, hot and cold water mixing set
17. Soap and towel dispenser
18. Water and drainage pipes concealed in wall

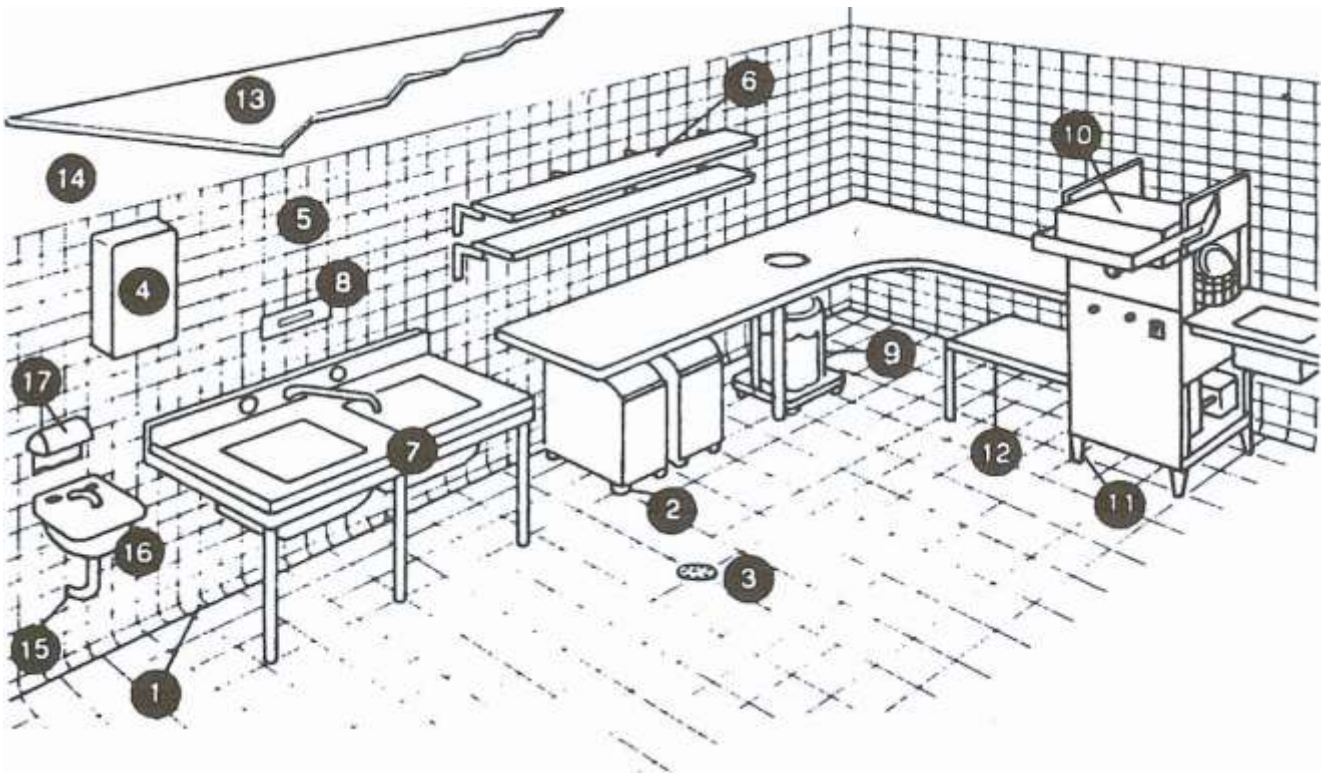

Requirements – typical wash-up area

1. Floor/wall coving
2. Casters to under-bench storage
3. Impervious floor graded and drained
4. Hot water heater sealed to wall
5. Walls finished as per section 7 of this guide
6. Shelving
7. Sink unit
8. Thermometer
9. Garbage receptacle
10. Dishwasher with temperature indicating device
11. Legs to allow effective and easy cleaning
12. Bottom shelf height above the floor to allow effective and easy cleaning
13. Rigid smooth faced ceiling
14. Smooth trowelled cement (polished surface)
15. Water and drainage pipes concealed into walls
16. Hand basin, hot and cold water mixing set
17. Soap and towel dispenser

example plans of a mobile food vehicle

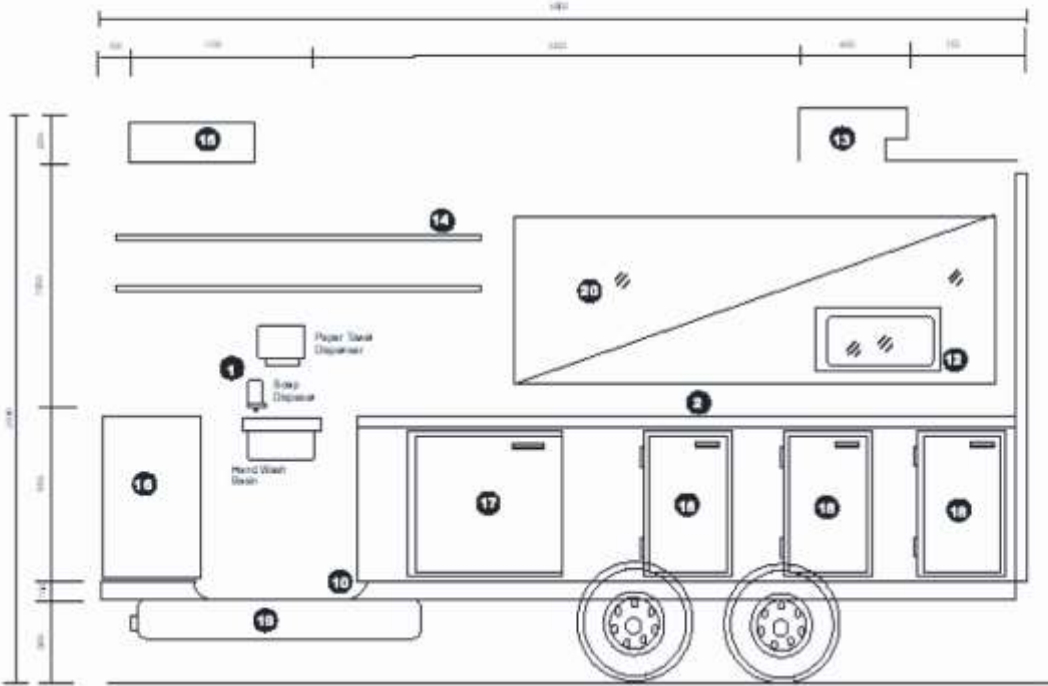
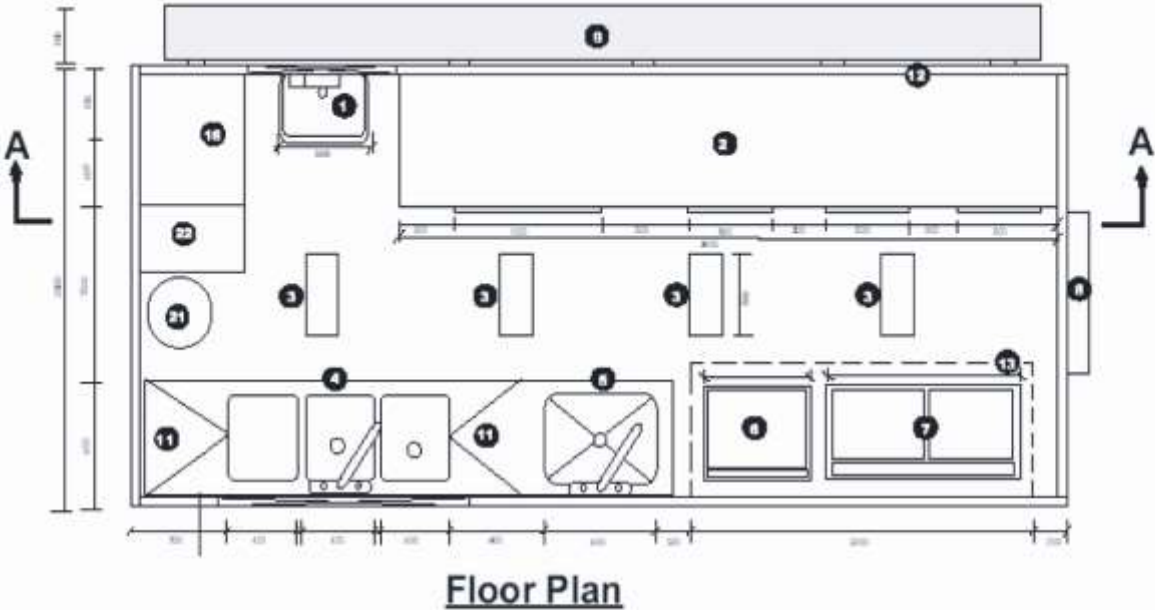

Legend - example plans of a mobile food vehicle

1. Hand wash basin provided with hot and cold water through single spout supplied with liquid soap and paper towel dispensers fixed directly above
2. Food preparation bench of impervious construction
3. Ample fluorescent lighting
4. Three compartments/dishwasher sink (hot and cold mixed water faucet)
5. Food preparation/large pot wash sink (hot and cold mixed water faucet)
6. Cooktop/Grill natural gas fitted with large wheels for cleaning requirements
7. Commercial natural gas deep fryer with large wheels for cleaning requirements
8. Self-closing entrance door
9. Folding table made of impervious material
10. Commercial grade seamless vinyl flooring coved to walls
11. Folding table made of impervious material
12. Self-closing screened pass-out window
13. Mechanical exhaust extraction unit compliant with relevant Australian Standard discharge vent screened to prevent pest and vermin entry
14. Shelving sealed to wall
15. Gravity portable water storage unit tank - food grade reinforced plastic
16. Storage cupboards – personal effects, cleaning equipment/chemicals
17. Gas operated commercial freezer unit fitted with external temperature gauges accurate to +/-1°C
18. Gas operated commercial refrigeration unit fitted with external temperature gauges accurate to +/-1°C
19. Waste water tank
20. Window
21. Swing window perspex for protection from exterior dust
22. Waste bin with close fitting lid

Glossary

Adequate supply of water	Potable water available at a volume, pressure and temperature adequate for the purposes for which the water is used
Australian/New Zealand Standards	Australian Standard/New Zealand Standards are documents which are referenced by legislation to provide more detail on requirements and technical procedures. These standards can be purchased from Standards Australia on 131 242 or by visiting its website at www.saiglobal.com
Contaminant	Contaminant means any biological or chemical agent, foreign matter or other substances that may compromise food safety or suitability
Coving	A curved junction between the floor and the wall
Contamination	The introduction or occurrence of a contaminant in food
Easily moveable	Equipment that can be moved by one person (either on wheels, castors or sitting on the surface) to enable cleaning as often as necessary to ensure that, for example, food debris can be swept from underneath and the floor mopped. If the equipment cannot be easily moved, a clearance space must be provided so the area surrounding and beneath the equipment can be cleaned without moving the appliance
Equipment	Includes a machine, instrument, apparatus, utensil or appliance - other than a single use item– used or intended to be used in or in connection with food handling. It also covers any equipment used or intended to be used to clean the food premises or equipment
Food grade	Utensils, substance or any material that has been designed, manufactured and proved to be safe to be used in the course of food production. The use must be specific in terms of quantity and manner in that such use will not produce any immediate or potential harm to the consumer of the food with which the material has been used in the course of its production
Food business	A business, enterprise or activity (other than primary food production) that involves: <ul style="list-style-type: none"> • handling of food intended for sale, or • sale of food regardless of whether the business enterprise or activity concerned is of a commercial, charitable or community nature or whether it involves the handling or sale of food on one occasion only
Food premises	Any premises including land, vehicles, parts of structures, tents, stalls and other temporary structures, boats, pontoons, including premises used principally as a private dwelling
Food Safety Standards	These are part of the Food Standards Code (Chapter 3) and define requirements for food premises on food handling practices and the structural requirements of food premises
Handling of food	Includes the making, manufacturing, producing, collecting, extracting, processing, storing, transporting, delivering, preparing, treating, preserving, packing, cooking, thawing, serving and displaying of food

Homestay	A dwelling providing short-term guest accommodation
Potable water	Potable water is safe drinking water that is fit for human consumption
Potentially hazardous food	Food that has to be kept at certain temperatures to minimise the growth of any pathogenic micro-organisms that may be present in the food and/ or to prevent the formation of toxins. This may include meat, seafood, dairy products, orange juice and cooked rice.
Relevant local government	This is the local government or Council for the area in which the food business is located.
Rinsing baskets	Containers usually of wire or heat resistant plastic or perforated steel that can be submerged in hot water to sanitise utensils
Safe and suitable food	Food is considered safe if it is unlikely to cause physical harm to a person who might later consume it, assuming they treated the food correctly after purchase. Food is considered suitable if it is not damaged, deteriorated or perished to an extent that affects its intended use, e.g. out of date, poor maintenance or poor storage of chemicals, or contains a substance that is foreign to the nature of the food, i.e. foreign matter or chemicals which may have fallen into the food.
Sanitising	A process that significantly reduces the number of micro-organisms present on a surface. This is usually achieved by the use of hot water and or chemical sanitisers.
Sewage	Discharge from toilets, urinals, basins, showers, sinks and dishwashers through a sewer or other means.
Sinks	Includes sinks for food preparation, cleaner's sink, utensil and equipment washing, and personal hand washing basins.
Temperature control	Maintaining potentially hazardous food at a temperature of: <ul style="list-style-type: none"> • 5°C or below is necessary to minimise the growth of infectious or toxin producing micro-organisms in the food so that the microbiological safety of the food will not be adversely affected for the time the food is at that temperature, or • 60°C or above, or • another temperature - if the food business demonstrates that maintenance of the food at this temperature for the period of time for which it is so maintained will not adversely affect the microbiological safety of the food
Warm water	Not hotter than 50 °C - to comply with Australian Standard 3500.4:2003 (Plumbing and drainage: Part 4 – heated water services).

